

FORMAX[®]

Industrial Conveyor Shredders

FD 8802CC Cross-Cut

FD 8802SC Strip-Cut

MACHINE SPECIFICATIONS		
Model Type	FD 8802CC	FD 8802SC
Serial #:		
Shred Size:	1/4" x 2"	1/2"
Sheet Capacity:	75 - 90	105 - 125
Speed:	Up to 40 fpm	Up to 50 fpm
Throat Width:	16"	16"
Waste Bin Capacity:	36 gallons	49 gallons
Motor:	1.5KW (2HP)	1.5KW (2HP)
Power:	3-Phase, 220V, 50/60Hz, both models	
Weight:	661 lbs.	661 lbs.

The serial number is specified on the nameplate of the shredder. Guarantee claims and inquiries cannot be processed if you do not quote the serial number.

Enter this number into the nameplate shown here immediately after receipt of the shredder.

TABLE OF CONTENTS

TOPIC	PAGE
Safety Precautions	1-2
Checking Safety Devices	3
Overview	4
Machine Characteristics	5
Cutting Data, Speed, Dimensions, Weight	5
Motor Specifications, Power Requirements	5
Installation	5
Start-up: Main Switch and Control Panel	6
Operation, Overloading	7
Maintenance: Emptying Waste Bin	8
Maintenance: Removing Side Covers	8
Maintenance: Conveyor Belt Maintenance	8-9
Maintenance: Lubricating Shredder Mechanisms	10
Maintenance: Exterior Cleaning	10
Parts Lists	11-19

Safety Precautions

“Work safety” symbol



This symbol marks all work safety notes in this manual which can endanger the health or life of operators. Please pay attention to this symbol and exercise particular care in such cases. Please also forward all work safety notes to other users. Apart from the instructions in this manual, you should also follow generally applicable safety and accident prevention regulation.

“Attention” notes



This icon marks information in this manual which requires particular attention including guidelines, regulations, instructions and correct working procedures intended to prevent damage to the machine and/or other equipment.

Notes on work safety

The FD 8802 shredder has been inspected for safety. However, improper operation and misuse risk the following:

- the health or life of the operator
- the machine and other valuable equipment
- the efficient operation of the shredder.

The FD 8802 employs state-of-the-art technology and is safe to operate. However, this machine can become hazardous if used incorrectly, by untrained staff or for purposes other than those for which it is designed.

- Material with a tendency to curl, e.g. tapes, cords, etc. should not be processed.
- Keep long hair, loose clothes, ties, scarves, etc. away from paper feed opening.
- Only one person should operate the shredder at a time.
- Always follow local safety and accident prevention regulations when operating the shredder.
- No pedestals or other raised surfaces may be placed in the vicinity of the machine if they alter the safety clearances.
- All connecting cables must be laid in such a way that they cannot be tripped over.
- Mechanical wearing parts must be inspected once a year.

The FD 8802 shredder is intended **only** for shredding paper, paperboard and cardboard. It is designed for shredding large volumes of archive files, bound EDP lists and the contents of waste paper bins. The hardened, solid-steel cutting rollers are unaffected by loose-leaf binders, paper clips and staples contained in these materials.

Any other use beyond the scope described here is regarded as not being in accordance with the instructions. The manufacturer will not be held liable for damage resulting from incorrect use; the user alone is responsible.

Users must also follow the assembly, dismantling, re-assembly, operation and maintenance procedures specified by the manufacturer. The operation, maintenance and repair of the machine must be performed only by trained personnel who are aware of the potential dangers.

The relevant accident prevention regulations as well as other generally recognized rules concerning safety engineering and occupational safety must be observed.

- Each person responsible for assembling, dismantling and reassembling and maintenance (inspection, servicing, repair) of the shredder must have read and fully understood the entire operating manual, in particular the "Safety" section.
- The shredder may only be operated, serviced and repaired by authorized, trained personnel.
- The shut-down procedures specified in this manual must be followed during all assembly, dismantling and re-assembling, cleaning, and maintenance work. This type of work must be performed only when the machine is idle.
- The drive of the FD 8802 must be secured against unintentional switching-on before performing work on the machine. Set the main switch to "Off" and unplug machine from wall outlet.
- After repair, check all protective devices to be sure they have been re-installed before operation.
- Do not perform any work which may impair your safety while operating the machine.
- Immediately report any changes which impair your safety to the person responsible. Shut the machine down until such damage has been resolved.
- Before operating the shredder, ensure that it is in perfect working condition.
- Ensure that the workplace around the FD 8802 is always clean and safe.
- The user must not make any conversions or changes on his own initiative which impair the safety of the FD 8802. Protective devices must not be removed or rendered inoperative.
- All work which is not directly connected to the normal operation of the machine must always be performed when the machine is idle.
- Doors and flaps must not be opened until the machine is motionless. Observe safety labels!
- Test the safety features after installing or repairing electrical components.

Checking the safety devices

Check the safety devices:

- at the start of each work shift (when operation is sporadic)
- at least once a week in continuous operation
- after each maintenance or repair

Check the safety devices for:

- specified condition
- specified location
- safe attachment
- specified function

Correct defects before you operate the shredder.

1. Immediately shut down the shredder if defects occur during operation and make sure the defects are corrected.
2. Do not modify or remove protective devices. Do not switch off protective devices. For safety reasons, modifications of the machine are not allowed.



Danger: Defective safety devices can cause serious accidents. If safety devices are not working properly, the shredder should immediately be put out of operation.

Never reach into the cutting system while it is operating; you risk serious injury!

Only when all safety devices are operating correctly can the shredder be used again.

Operate the shredder only when these devices have been checked and are in order.

1. Check the **Safety Bar** push button (A) in front of the feeding table:

The shredder must switch off immediately when you press the **Safety Bar** button and the Emergency stop light must go on.

2. Check the **Stop** button (B) on the right of the control panel:

The shredder must switch off immediately when the button is pushed.

3. Check the **Safety Switch** inside the Cutting Block Access Door at the top of the shredder (C). Press the door handle release. Handle will rotate up. Pull up on handle.

The shredder must switch off immediately when the door is opened.

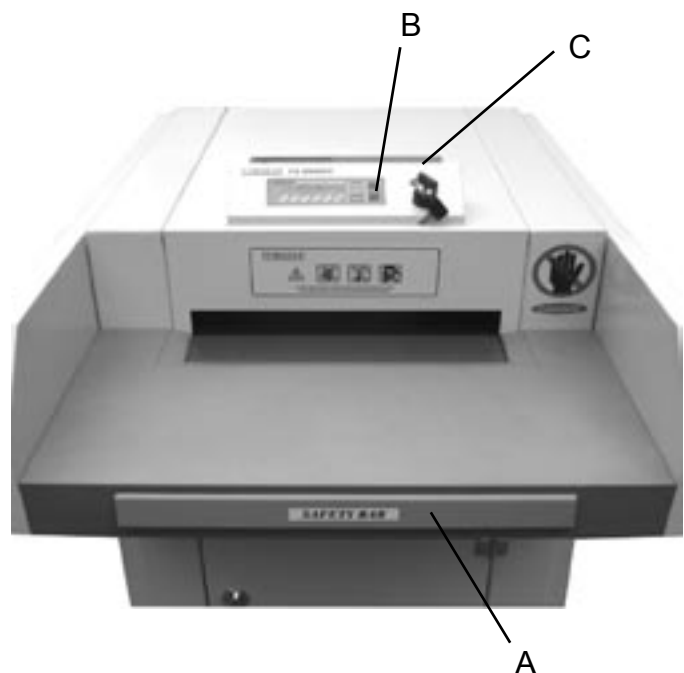

General Overview



Front View with Waste Bin



Breaker Panel



**Control Panel and
Cutting Block Access Door**



**Right Side View with Electricity
Control Box Access Door**

Machine characteristics

Machine designation: conveyor-belt paper shredder

Machine type: FD 8802CC, FD 8802SC

Total machine weight: 661 lbs.

Technical equipment: large feeding table, inlet conveyor belt

Cutting Data, Speed, Dimensions, Weight

	FD 8802CC	FD 8802SC
Cutting Style:	Cross Cut	Strip Cut
Shred Size:	1/4" x 2"	1/2"
Sheet Capacity:	75 to 90	105 to 125
Speed:	Up to 40 feet per minute	Up to 50 feet per minute
Feed Opening:	16"	16"
Dimensions:	29" W x 47" D x 42" H	29" W x 51" D x 46" H
Feed Table Dimensions:	28 1/4" W x 16" D x 41.5" H	28 1/4" W x 16" D x 41.5" H
Space Requirements:	32" W x 51" L x 55" H	32" W x 55" L x 59" H
Waste Bin Capacity:	36 gal.	49 gal.
Weight:	661 lbs.	661 lbs.

Motor Specifications, Power Requirements

Motor Type	Horizontal Geared
Rated Power	1.5KW (2HP)
Operating Voltage	220V
Phase	3-Phase
Frequency	50/60Hz
Rated Current	20A
Output RPM	25 RPM
Number of Poles	4 (3 hot & 1 ground)
Total Rated Power Pn	1.5KW
Total Rated Current In	20A
Total EOCR Protection	25A

Installation

1. Appropriate power outlet must be available at installation site.
2. The FD 8802 is delivered completely assembled (although it can be delivered in parts, if necessary.) During transport, be aware of the shredder's high center of gravity.
3. The shredder can be moved on its casters. If a fork-lift is used to transport the machine, be sure to use the designated pick-up points.
4. Install the shredder on a flat and even floor without carpeting.
5. Once the shredder is in place, lock the caster brakes, and plug in power cable to appropriate power source.



Power Plug



Power Outlet

Start-up and Operation

Main Switch

1. On the right side of the machine, open the orange door leading to the electrical control panel. Push on the lever (Fig. 1) and the handle will pop out. Pull to open (Fig. 2).
2. Flip the main power switch to the UP position (Fig. 3).
3. Insert key into On-Off switch to right of control panel (Fig. 4). Turn key right, to the On position.



Fig. 1



Fig. 2

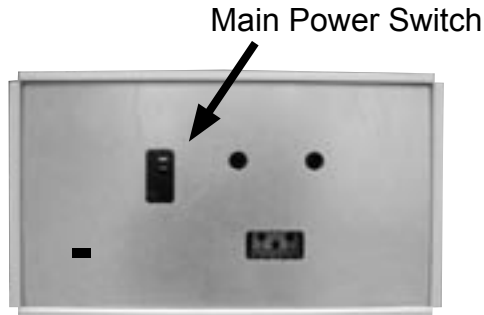

Fig. 3



Fig. 4

Control Panel

START
Green Touch Pad
Push to start conveyor and cutting blade operation. Cutting system operates in feed direction.

REVERSE
Blue Touch Pad
Push button to reverse direction of cutting blades.

STOP
Red Touch Pad
Push button to stop cutting system. Shredder remains in standby mode until Start is pressed.

LOAD INDICATOR
Lights to show how close shredder is to capacity, or if overloaded.

MODE INDICATORS
Indicators light to show the shredder's status: Auto, Manual, Stop, Reverse

WASTE BIN FULL
Indicator lights when waste bin is full of paper shreds.

DOOR OPEN
Indicator lights to show when waste bin door is open. (Shredder will not operate if door is open.)

Operation

1. Set main switch to ON (Fig. 3). Turn the OFF/ON key switch on the control panel to the ON position.
2. Touch the START pad on the control panel. The conveyor will begin to move in the forward direction.
3. Place the material to be shredded on the feed table, then slide onto the inlet conveyor belt, in appropriate stacks. (Cross-Cut, up to 90 sheets. Strip-Cut, up to 125 sheets. Sheet capacity may vary due to variables in paper thickness and power supply.)

NOTE: If material is accidentally placed onto the conveyor belt, DO NOT REACH FOR IT. Instead, press the Safety Stop bar on the front of the shredder, or press the red STOP pad on the control panel. When the shredder stops, press and hold the REVERSE pad. The conveyor should operate in reverse, allowing safer access to the materials. The shredder will stop when the REVERSE pad is released. To resume shredding, press the START pad.

Turning off the shredder

1. To shut down the shredder, press the STOP pad on the control panel.
2. Turn OFF/ON key switch on the control panel to the OFF position.
3. Open the electrical control panel door, and flip the main power switch DOWN to the off position.

Overloading the motor

If the shred capacity of the machine is exceeded (too large a stack of paper, etc.), the shredder will stop automatically. To resume shredding:

1. Push and hold the reverse pad until the paper backs completely out of the shredder.
2. Press the red STOP pad or the SAFETY BAR on the front of the machine, then divide the materials into smaller stacks.
3. Press the START pad. The conveyor and internal shredding mechanisms will begin to move.
4. Continue shredding, feeding less paper at a time.

Frequent Overloading

If the shredder is repeatedly overloaded, the motor can overheat, which will cause the shredder to switch off automatically. To resume shredding:

1. Allow the motor to cool down for approximately 20 - 30 minutes before using.
2. Once the motor has cooled sufficiently, resume shredding by following standard operating procedure (see Operation).



NOTE:

To maintain optimum performance and allow constant operation, avoid repeatedly overloading the shredder. This will prevent time-consuming reversing cycles, and will provide the highest possible throughput.

Maintenance and Inspection

Emptying the Waste Bin

Shredded paper and particles accumulate in the shredder waste bin during normal operation. When the red “Waste Bin Full” lamp lights, empty the waste bin.

1. Switch the shredder off by pressing the STOP pad on the control panel, turn the OFF/ON key switch to the OFF position and flip the main power switch to the OFF position.
2. Turn the door handle to the right and open the waste bin access door. Pull out and empty the waste bin.
3. Push the waste bin back in, close the door, turn power switches back on and resume shredding.



NOTE: The maintenance procedures which follow should be performed only by authorized and trained technicians.

Removing & Reinstalling Side Covers

Each side cover is attached by four Phillips head screws.

1. To remove a cover, insert screwdriver through access holes (Fig. 4), and remove screws.

NOTE: It is easier to remove the lower two screws first, then the top two. When reinstalling the cover, install top screws first, then lower.



Fig. 4

Conveyor Belt Maintenance

- **Checking Belt Tension**
When loaded with material, the conveyor belt must not slip, i.e. stand still when material is loaded. If the belt slips, it must be tightened. Contact the Formax Service Department for assistance.
- **Checking Belt for Wear**
The upper surface of the conveyor belt can become worn over time. The belt must be replaced when the woven fabric inlay becomes visible. Contact the Formax Service Department for assistance.
- **Cleaning the Conveyor Belt area**
The conveyor belt area must be cleaned once a month, or as needed to maintain optimal performance.
 1. Switch off the shredder and unplug from wall outlet.
 2. Remove the covers on both sides, revealing the cleaning openings in the conveyor belt area.
 3. Use compressed air to blow out particles, or a vacuum to remove dirt and dust.
 4. Re-install both side covers.

NOTE: Paper clips in the shredded materials may increase the frequency of cleaning necessary, and may become caught in the sides of the belt.

- **Cleaning the Conveyor Belt Tensioning Station**

The tensioning station must be cleaned once a month, or as needed to maintain optimal performance.

1. Switch off the shredder and unplug from wall outlet.
2. Remove the feed table and front panel of tensioning station (Fig. 5).
3. Remove particles and dirt.
4. Re-install the feed table and front panel of tensioning station.

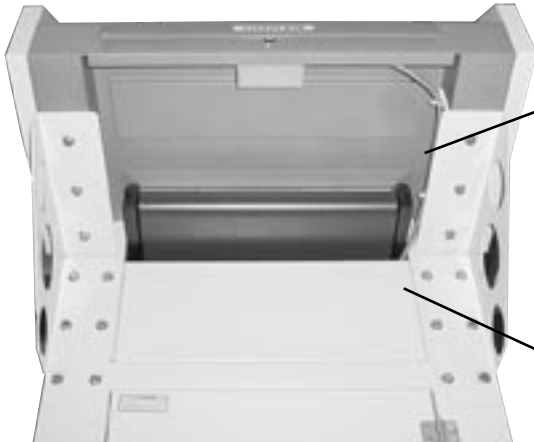

Fig. 5
Front Underside



Fig. 5 detail

Tensioning station
adjuster

- **Checking the Cutting Head Chain Tension**

Check the chain tension once every week in the first month, then once a month thereafter.

1. Switch off the shredder and unplug from wall outlet.
2. Remove the right side cover.
3. The sagging of the chain (see Fig. 6) should be 9 - 14 mm, measured from the top inside of the frame to the cutting head chain.
If it is not within this range, loosen the tension screws until the sagging reaches the correct level. Retighten the tension nuts.
4. Replace the side cover, plug in the shredder.



NOTE:

Excessive tensioning of the chain can cause premature wear of the chain and bearings. The smallest allowed chain sagging in the first month of operation is 5 mm. After that, 9 mm.

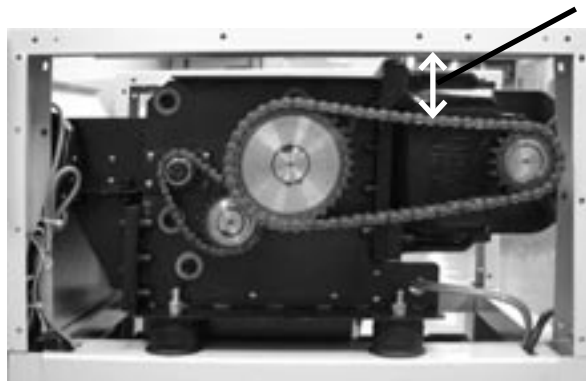

Fig. 6

Lubricating Shredder Mechanisms

- Cutting System:

The cutting system should be oiled once a month or as needed for optimal performance.

1. Open the Cutting Block Access Door on the top of the shredder. Press latch and the handle will spin around. Pull up on the handle.
2. Spray special cutting block oil through the paper inlet, onto the cutter rolls.
3. Close the Access Door and press the START button on the control panel.
4. Run the cutting system forward and backward several times, *without feeding paper*. This will help to remove paper shreds and particles.

- Drive Chains:

The drive chains should be checked during PMs, and greased as needed.

1. Switch off the shredder and unplug from wall outlet.
2. Remove both side covers.
3. Grease the cutting system conveyor belt drive chain (A) and the motor cutting system drive chain (B).
4. Replace side covers and plug in shredder.

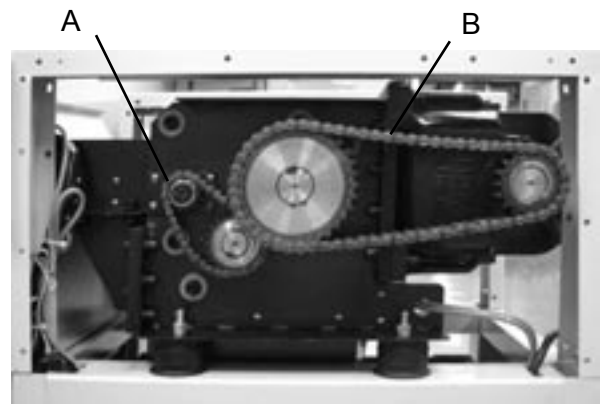

Right Side

- Synchronizing Wheels:

1. Switch off the shredder and unplug from wall outlet.
2. Remove left side cover.
3. Grease the synchronizing toothed wheel (C).
4. Replace side cover and plug in shredder.

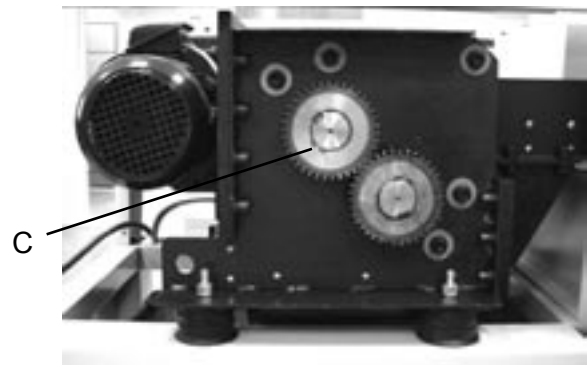

Left Side

Exterior cleaning

- Turn shredder off and unplug from wall outlet.
- Wipe the exterior surfaces with a soft cloth. If the surfaces are very dirty, use a neutral detergent, then wipe again with a soft cloth.

CAUTION:

- Never put water directly on the surface of the shredder.
- Never clean the case with benzene or thinner, since it will cause discoloration.

PARTS LISTS

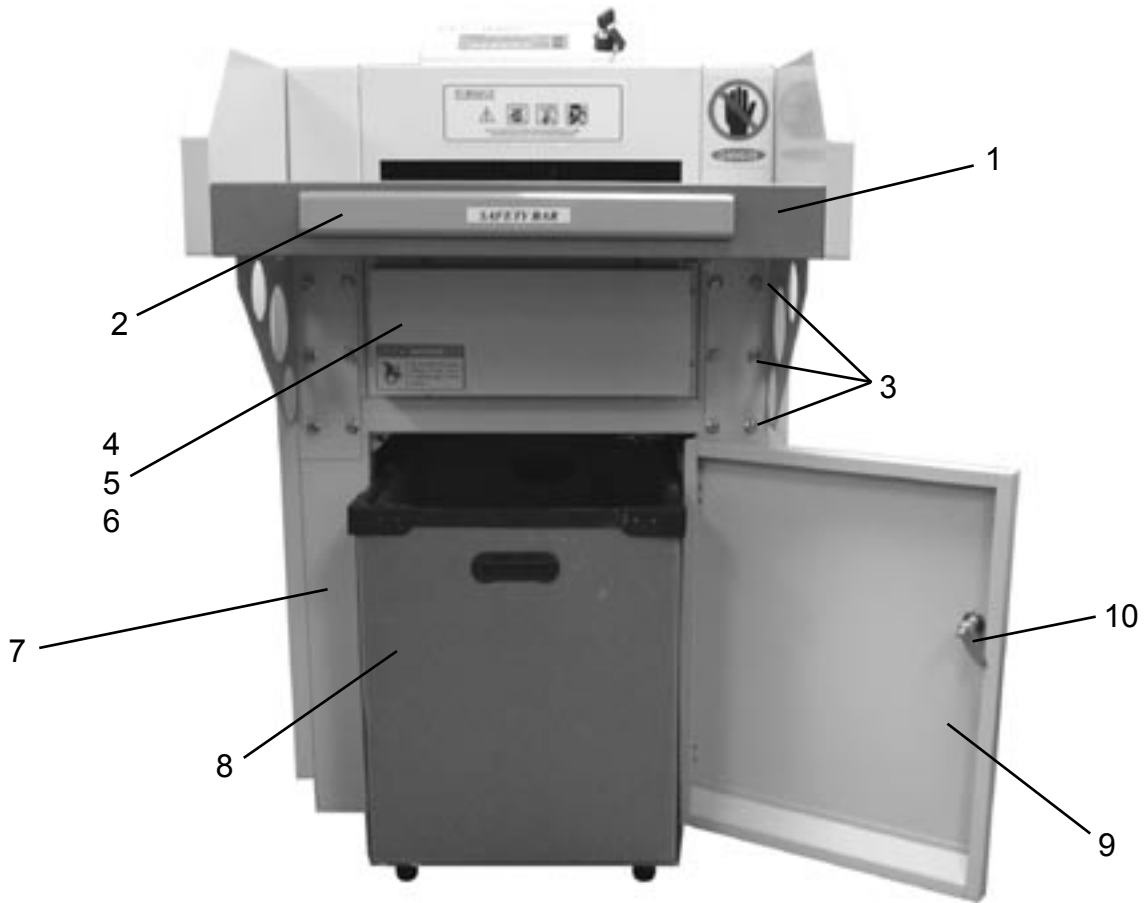

ITEM	CC PART #	SC PART #	DESCRIPTION	QTY
1	8802-TOP-02	8802-TOP-02	LOADING TABLE	1
2	8802-SAB-01	8802-SAB-01	SAFETY BAR	1
3	8802-BOL-01	8802-BOL-01	BOLTS FOR LOADING TABLE SUPPORTER	18
4	8802-TOP-05	8802-TOP-05	FRONT CASE	1
5	8802-TOP-06	8802-TOP-06	PCB FRONT COVER	1
6	8802-PCB-07	8802-PCB-07	PCB CASE (INSIDE, NOT SHOWN)	1
7	8802-BOD-01	880213-BOD-01	LOWER FRAME	1
8	8802-WST-01	880213-WST-01	WASTE BIN	1
9	8802-BOD-05	880213-BOD-05	DOOR	1
10	8802-LAT-01	8802-LAT-01	WASTE BIN DOOR LATCH	1

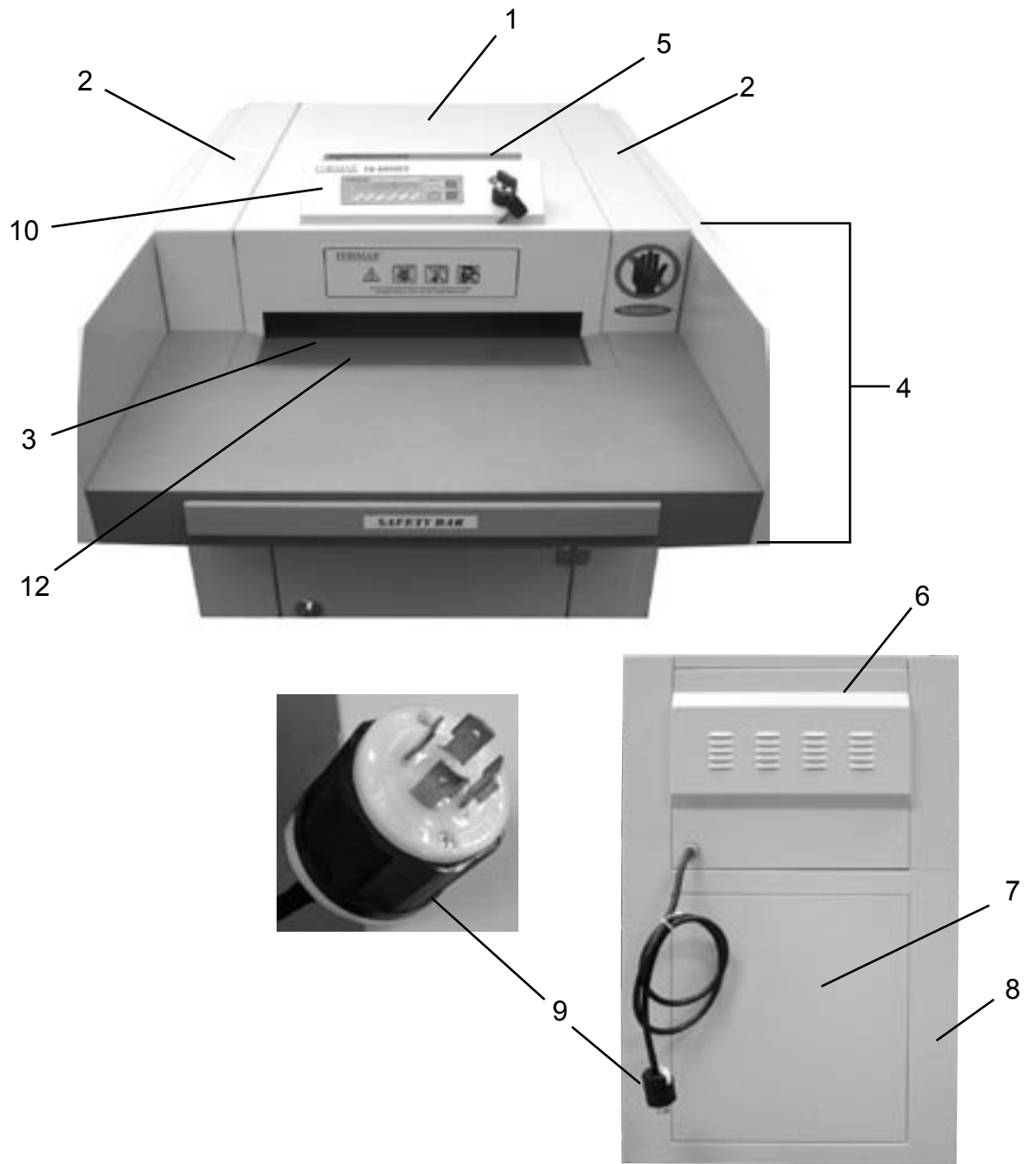

ITEM	CC PART #	SC PART #	DESCRIPTION	QTY
1	8802-TOP-01	880213-TOP-01	TOP CASE	1
2	8802-TOP-03	880213-TOP-03	UPPER FRAME	2
3	8802-BEL-01	8802-BEL-01	CONVEYOR BELT	1
-	8802-CON-01	880213-CON-01	CONVEYOR	1
4	8802-TOP-02	8802-TOP-02	LOADING TABLE	1
5	8802-DOR-01	8802-DOR-01	CUTTING BLOCK ACCESS DOOR	1
6	8802-TOP-04	8802-TOP-04	REAR CASE UPPER	1
7	8802-BOD-02	880213-BOD-02	REAR CASE LOWER	1
8	8802-BOD-01	880213-BOD-01	LOWER FRAME	1
9	8802-PCB-19	8802-PCB-19	POWER PLUG, 30A	1
10	8802-TOP-07	880213-TOP-07	CONTROL PANEL COVER	1
11	8802-HIN-01	8802-HIN-01	WASTE BIN DOOR HINGE	2
12	8802-BEL-02	8802-BEL-02	CONVEYOR BELT PLASTIC STRIP	1

Right Side

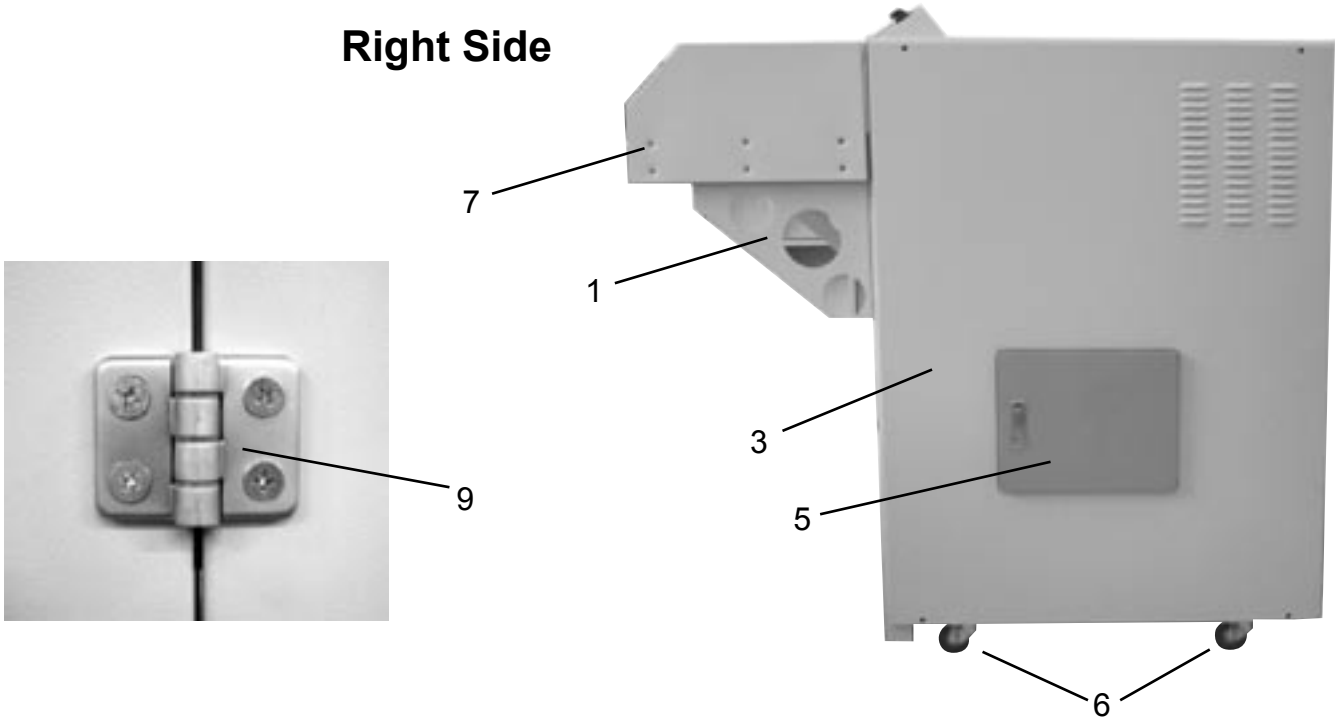

Left Side

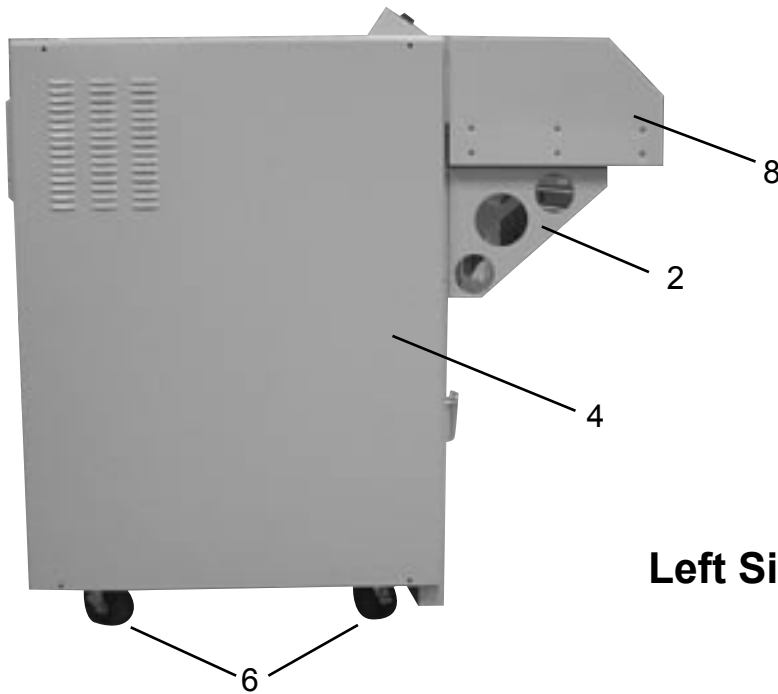

ITEM	CC PART #	SC PART #	DESCRIPTION	QTY
1	8802-TOP-06R	8802-TOP-06R	LOADING TABLE SUPPORTER, RIGHT	1
2	8802-TOP-06L	8802-TOP-06L	LOADING TABLE SUPPORTER, LEFT	1
3	8802-BOD-03	880213-BOD-03	SIDE CASE, RIGHT	1
4	8802-BOD-04	880213-BOD-04	SIDE CASE, LEFT	1
5	8802-PCB-02	880213-PCB-02	ELECTRICITY CONTROL BOX DOOR	1
6	8802-CAT-01	880213-CAT-01	CASTERS	4
7	8802-TOP-07R	8802-TOP-07R	LOADING TABLE SIDE PANEL, RIGHT	1
8	8802-TOP-07L	8802-TOP-07L	LOADING TABLE SIDE PANEL, LEFT	1
9	8802-HIN-01	8802-HIN-01	WASTE BIN DOOR HINGE	2

CUTTING HEAD - CC

Right Side

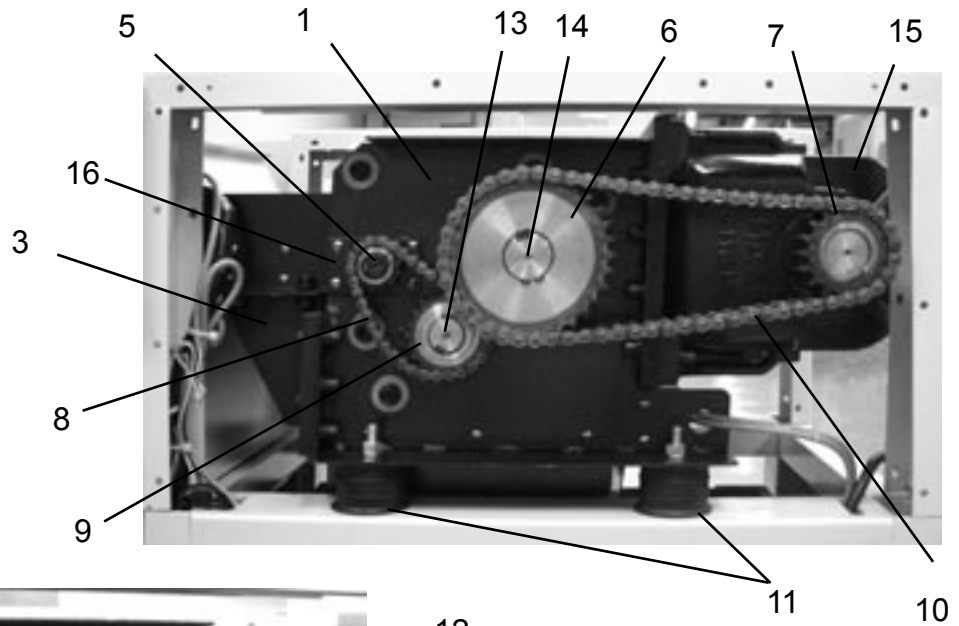

Left Side

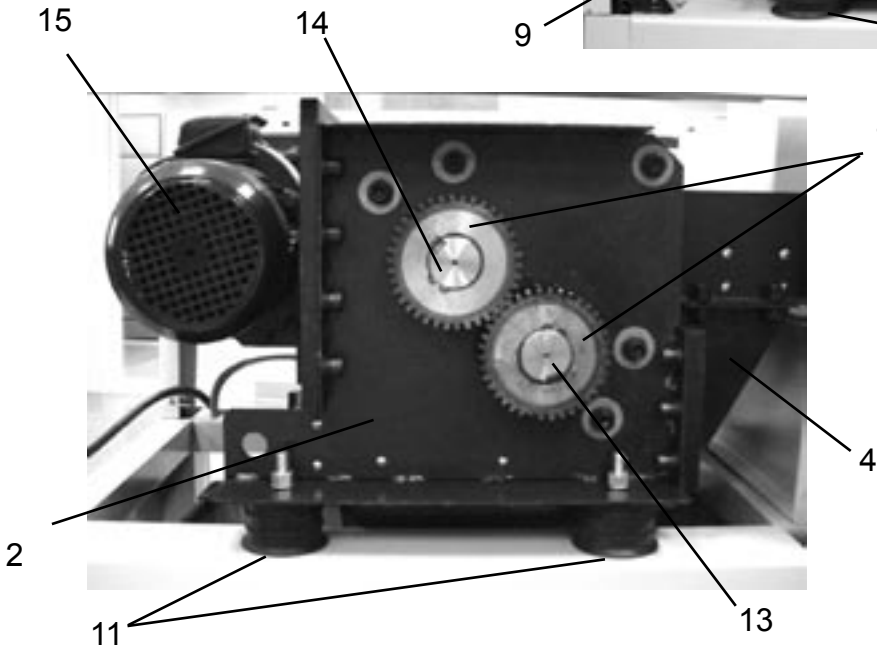

ITEM	CC PART #	DESCRIPTION	QTY
1	8802-CTB-02	SIDE PLATE, RIGHT	1
2	8802-CTB-01	SIDE PLATE, LEFT	1
3	8802-CON-03R	CONVEYOR BELT BRACKET, RIGHT	1
4	8802-CON-03L	CONVEYOR BELT BRACKET, LEFT	1
5	8802-SPR-02	CONVEYOR DRIVE SPROCKET	1
6	8802-GEA-01	CUTTING HEAD GEAR	1
7	8802-SPR-03	MOTOR SPROCKET	1
8	8802-CCH-02	CONVEYOR CHAIN	1
9	8802-SPR-01	CONVEYOR SPROCKET	1
10	8802-CCH-01	CUTTING HEAD CHAIN	1
11	8802-RUB-01	VIBRATION PROOF RUBBER (025)	4
12	8802-GEA-01	SYNCHRONIZING TOOTHED WHEEL	2
13	8802-CTB-08	SHORT SHAFT	1
14	8802-CTB-07	LONG SHAFT	1
15	8802-MOT-01	MOTOR	1
-	8802-CON-02	CONVEYOR SHAFT HOLDER	2
-	8802-CTB-05	MOTOR BASE PLATE	1
-	8802-CTB-00	CUTTING HEAD	1

CUTTING HEAD - SC

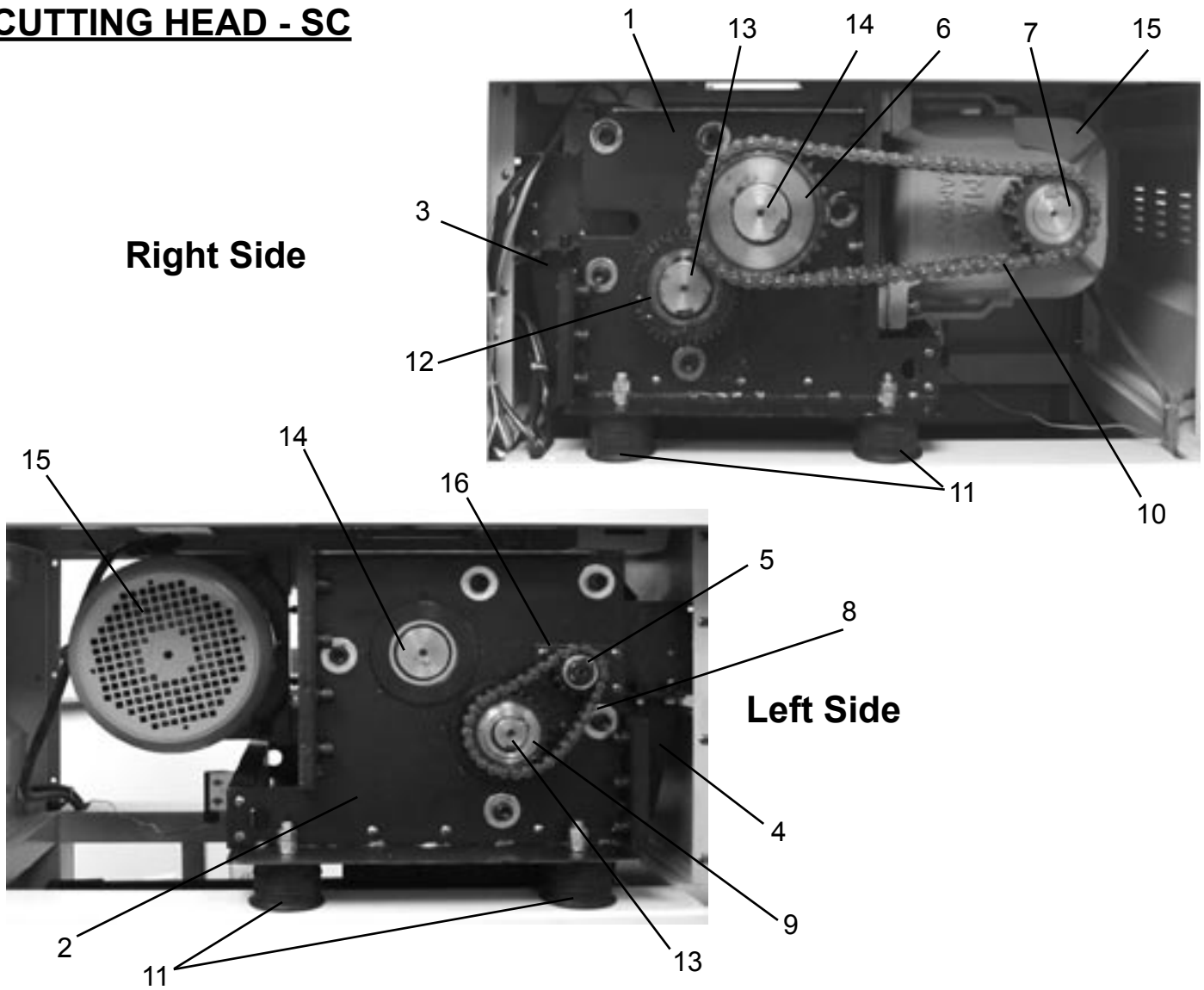

ITEM	SC PART #	DESCRIPTION	QTY
1	8802-CTB-02	SIDE PLATE, RIGHT	1
2	8802-CTB-01	SIDE PLATE, LEFT	1
3	880213-CON-03R	CONVEYOR BELT BRACKET, RIGHT	1
4	880213-CON-03L	CONVEYOR BELT BRACKET, LEFT	1
5	8802-SPR-02	CONVEYOR DRIVE SPROCKET	1
6	8802-GEA-01	CUTTING HEAD GEAR	1
7	8802-SPR-03	MOTOR SPROCKET	1
8	8802-CCH-02	CONVEYOR CHAIN	1
9	8802-SPR-01	CONVEYOR SPROCKET	1
10	8802-CCH-01	CUTTING HEAD CHAIN	1
11	8802-RUB-01	VIBRATION PROOF RUBBER (025)	4
12	880213-GEA-01	SYNCHRONIZING TOOTHED WHEEL	2
13	800213-CTB-08	SHORT SHAFT (0.5")	1
14	800213-CTB-07	LONG SHAFT (0.5")	1
15	8802-MOT-01	MOTOR, 220V, 60Hz, 3HP	1
16	8802-CON-02	CONVEYOR SHAFT HOLDER	1
-	880213-CTB-05	MOTOR BASE PLATE	1
-	880213-CTB-00	CUTTING HEAD	1

CUTTING HEAD - INTERIOR

CROSS CUT

STRIP CUT

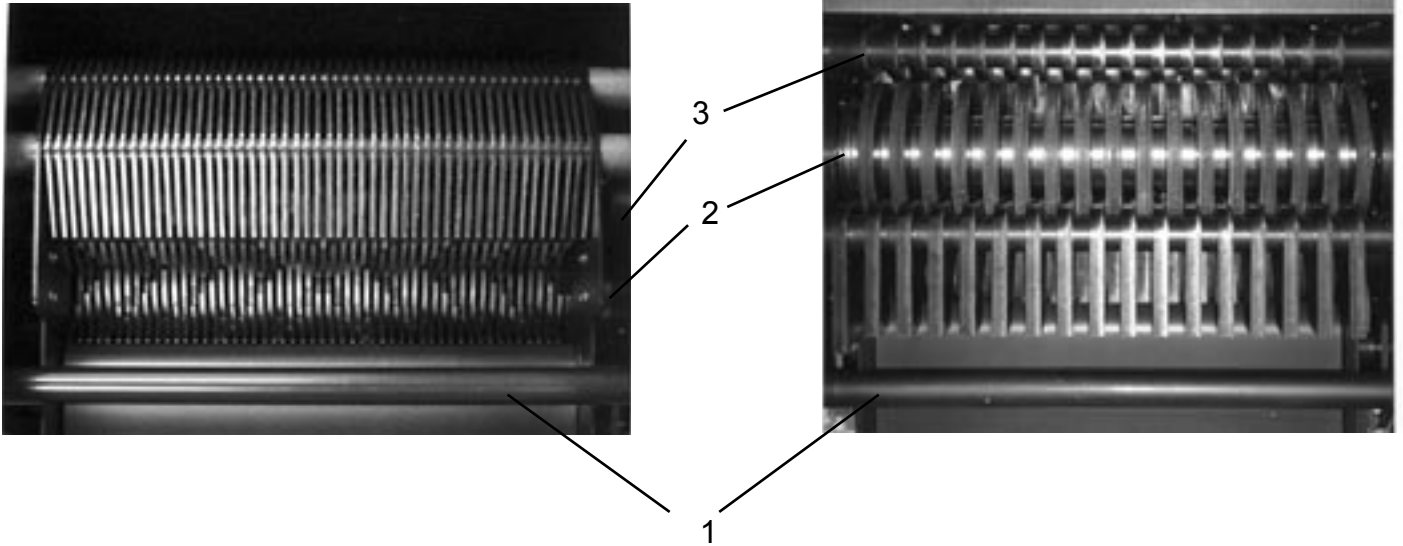

ITEM	CC PART #	SC PART #	DESCRIPTION	QTY
1	8802-CTB-03	8802-CTB-03	POST	5
2	8802-CTB-07	880213-CTB-07	LONG SHAFT (0.5")	1
3	8802-CTB-08	880213-CTB-08	SHORT SHAFT (0.5")	1
-	8802-CTB-09	n/a	CUTTER	-
-	8802-CTB-10	n/a	RING	-
-	8802-CTB-11	n/a	BEARING (6208 ZZ)	-
-	n/a	880213-CTB-09	BEARING (6209 ZZ)	-
-	8802-CTB-12	n/a	CUTTER PRESS WASHER	-
-	8802-CTB-13	n/a	BEARING WASHER	-
-	8802-CTB-14	n/a	BEARING NUT	-
-	8802-CTB-15	n/a	CUTTER NUT	-
-	8802-CTB-16	8802-CTB-16	BEARING HOUSING	-
-	8802-CTB-17	n/a	GUIDE REINFORCEMENT PLATE	-
-	n/a	880213-CTB-11	GUIDE REINFORCEMENT PLATE A	-
-	n/a	880213-CTB-12	GUIDE REINFORCEMENT PLATE B	-
-	8802-CTB-18	880213-CTB-13	UPPER GUIDE	-
-	8802-CTB-19	880213-CTB-14	LOWER GUIDE	-
-	8802-CON-02	8802-CON-02	CONVEYOR SHAFT HOLDER	2

ELECTRICAL

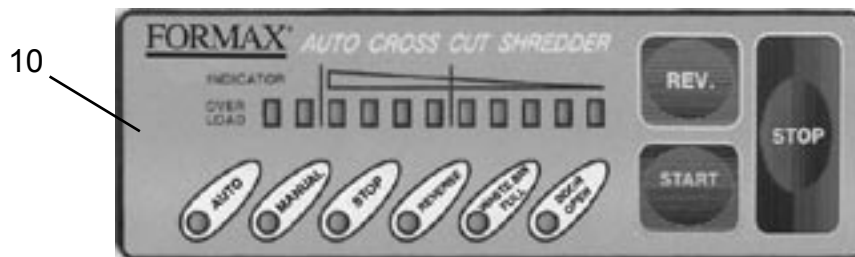
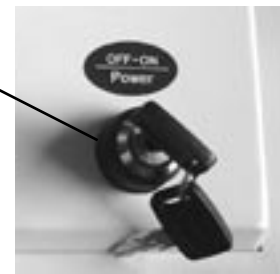
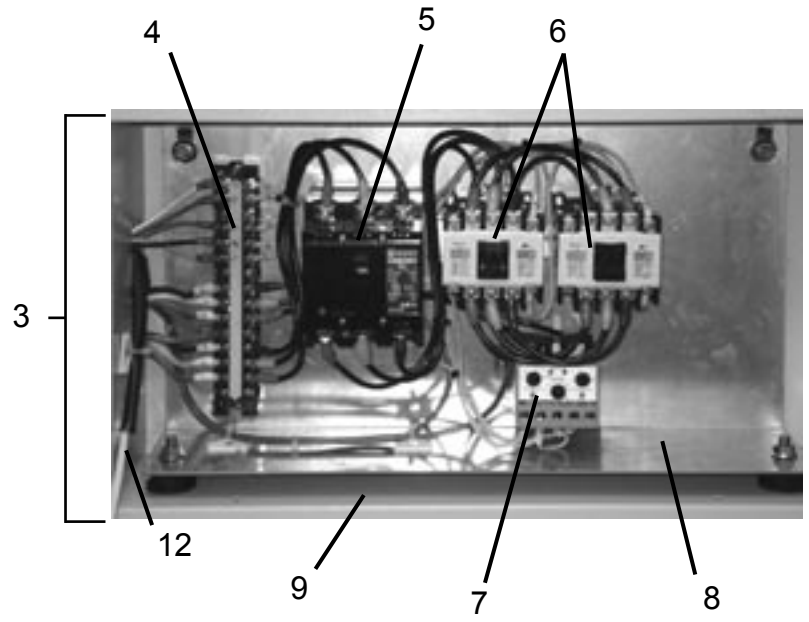
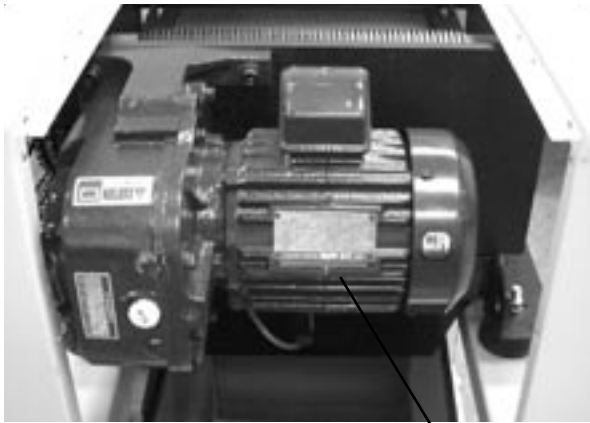

ITEM	CC/SC PART #	DESCRIPTION	QTY
1	8802-MOT-01	MOTOR, 220V, 60Hz, 3HP	1
2	8802-ECB-01	ELECTRICITY CONTROL BOX COVER	1
3	8802-PCB-00	ELECTRICITY CONTROL ASSEMBLY	1
4	8802-PCB-14	TERMINAL PLATE	1
5	8802-PCB-18	BREAKER	1
6	8802-PCB-15	MAGNETIC CORE	2
7	8802-PCB-04	EOCR	1
8	8802-PCB-01	ELECTRICITY CONTROL BOX BASE	1
9	8802-PCB-03	ELECTRICITY CONTROL BOX	1
10	8802-DEC-01	CONTROL PANEL DECAL	1
11	8802-TOG-01	ON/OFF TOGGLE SWITCH WITH KEY	1
12	8802-PCB-12	DATA OUTPUT CABLE	1

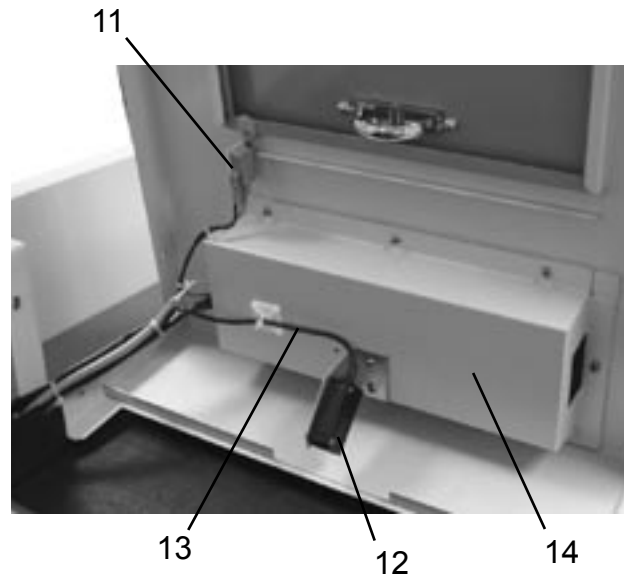
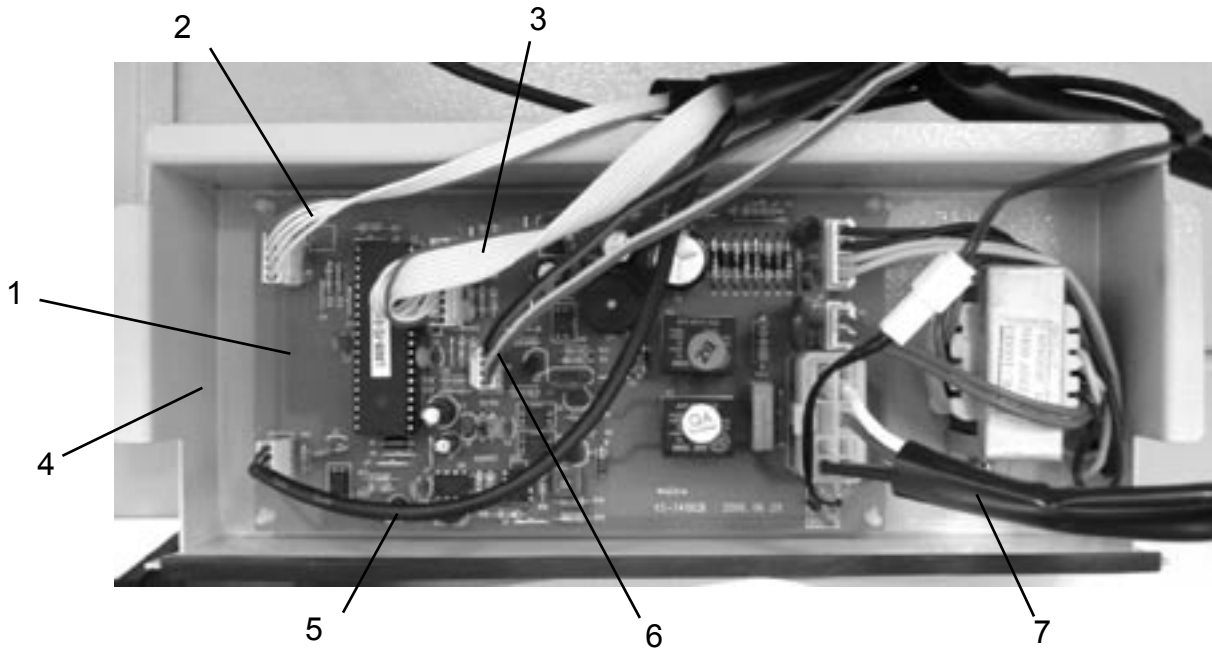

ITEM	CC/SC PART #	DESCRIPTION	QTY
1	8802-PCB-05	MAIN PCB	1
2	8802-PCB-12	DATA OUTPUT CABLE	1
3	8802-PCB-10	CONTROL PCB CABLE EXTENSION (BODY CABLE)	1
4	8802-PCB-07	PCB CASE	1
5	8802-PCB-20	SENSOR CABLE EXTENSION (BODY CABLE)	1
6	8802-PCB-13	DOOR SENSOR CABLE	1
7	8802-PCB-11	MAIN CABLE	1
8	8802-PCB-19	CONTROL PCB CABLE (SENSOR CABLE)	1
9	8802-PCB-06	CONTROL PCB	1
10	8802-SWI-1	WASTE BIN DOOR SWITCH	1
11	8802-PCB-16	MICRO SWITCH, CUTTING HEAD ACCESS DOOR, 15A	1
12	8802-PCB-08	SENSOR	1
13	8802-PCB-09	SENSOR CABLE	1
14	8802-PCB-21	CONTROL BOARD CASE	1

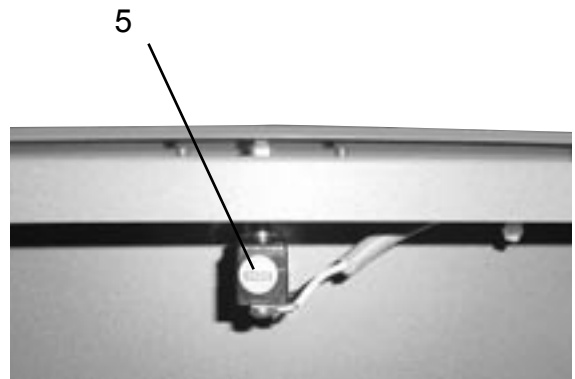
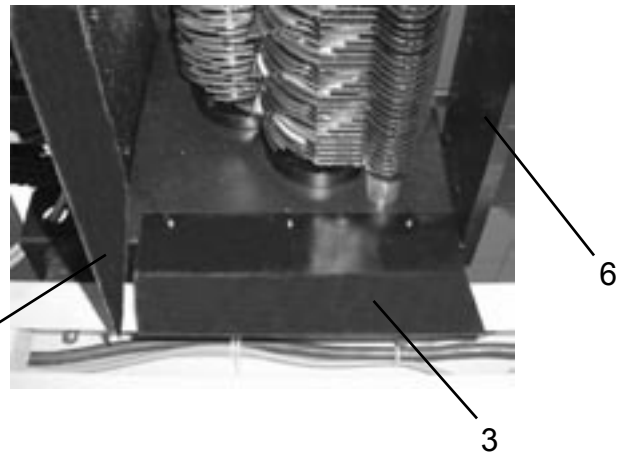
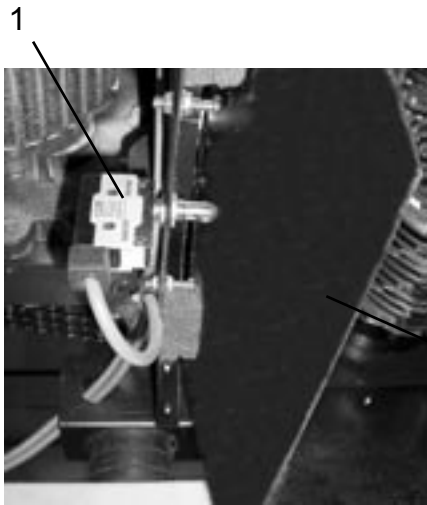

Underside View, Safety Bar and Micro Switch

Underside View, Feed Table and Conveyor

ITEM	CC/SC PART #	DESCRIPTION	QTY
1	8802-PCB-17	MICRO SWITCH, WASTE BIN FULL SENSOR, 15A	1
2	8802-CTB-20	WASTE GUIDE, REAR	1
3	8802-CTB-06	WASTE GUIDE, RIGHT AND LEFT	2
4	8802-SBM-02	COVER FOR SAFETY BAR MICRO SWITCH	1
5	8802-SBM-01	SAFETY BAR MICRO SWITCH	1
6	8802-CTB-04	FRONT WASTE PROOF PLATE	1