

FORMAX[®]

6202 Series
Folder/Insertter

OPERATOR MANUAL
FIRST EDITION



CONTENTS

Section	Page	Section	Page
1	Precautions	1	
1.1	Special national conditions	1	
2	General	2	
2.1	Understanding the system	2	
2.2	Operating controls	3	
2.3	Display	4	
3	Operating the system	4	
3.1	Switching on	4	
3.2	The main menu	4	
3.3	Main menu (1)	4	
3.4	Job info	4	
3.5	Other job	5	
3.6	Main menu (2)	5	
3.7	Reset count menu	5	
3.8	Adjustments for document feeding	5	
3.9	Adjustments for envelope feeding	8	
3.10	Insert position	8	
3.11	Fill & Start	9	
4	Job programming	9	
4.1	Job menu	9	
4.2	Job menu (1)	9	
4.3	Create job	9	
4.4	Edit job	9	
4.5	Job menu (2)	10	
4.6	Copy job	10	
4.7	Delete job	10	
5	Job settings	10	
5.1	Envelope settings	10	
5.2	Document settings	10	
5.3	Fold settings	11	
5.4	Double Feed Control	12	
5.5	OMR settings (Optional)	12	
5.6	Job name	12	
6	Optical Mark Reading (Optional)	12	
6.1	Adjustments	12	
6.2	Feeding documents	14	
6.3	OMR code	14	
7	Fault finding	15	
7.1	General	15	
7.2	Clearing stoppages	16	
7.3	Operator troubleshooting	17	
7.4	OMR error codes	20	
8	Maintenance	21	
8.1	Servicing	21	
8.2	General cleaning	21	
8.3	Cleaning the brushes	21	
8.4	Cleaning the moistening felt	21	
8.5	Cleaning the sensors	21	
9	Options	21	
10	Specifications	21	





1. PRECAUTIONS

Before using this system, thoroughly read the operating instructions. In the European Union an operator manual printed in the national language(s) is supplied with the system. If it is not, contact your authorized distributor.

Warning

- Before connecting check if the system is suitable for the local mains voltage; refer to the type plate.

Safety precautions

- This system is only to be operated by fully trained personnel. The manufacturer accepts no responsibility for injuries caused by unauthorized operation.
- The opening of covers must be carried out only by a skilled and authorized person who is aware of the hazard involved. The system will not operate with the covers opened.
- Keep long hair, fingers, jewellery, etc. away from turning parts of the system.
- The socket outlet shall be installed near the equipment and shall be easily accessible.
- The mains plug shall be connected only to a socket outlet provided with a protective earth contact.
- Over-current protection in the equipment also relies on the branch circuit protection (max. 20 A).
- The following part(s) is (are) considered the equipment disconnect device(s):
 - power supply cord plug.

Used symbols



Warning, this symbol indicates a wrong action which can cause a hazard to health or damage the system.

This symbol also means: read your operator instruction.



Warning, this symbol indicates a hazard to life because of high voltage.

Note: Additional information

1.1 Special national conditions

Denmark: In Denmark, certain types of Class 1 appliances may be provided with a plug not establishing earthing continuity when inserted into Danish socket-outlets. Be sure the equipment makes contact with the protective earthing of the socket outlet.

(Plug and socket outlet have to match!)

Japan: Provide an earthing connection before the mains plug is connected to the mains. When disconnecting the earthing connection, be sure to disconnect after pulling out the mains plug from the mains.



2. GENERAL

2.1 Understanding the system

This compact folding and inserting system can process large quantities of mail rapidly and easily.

The settings of the system are recorded in so-called jobs. These jobs can be programmed by an authorized user.

As a special feature the system is equipped with a Fill & Start function. The purpose of this function is to start working as quickly as possible.

The system consist of the following parts:

- ① feeder
- ② collating area
- ③ folder
- ④ inserter

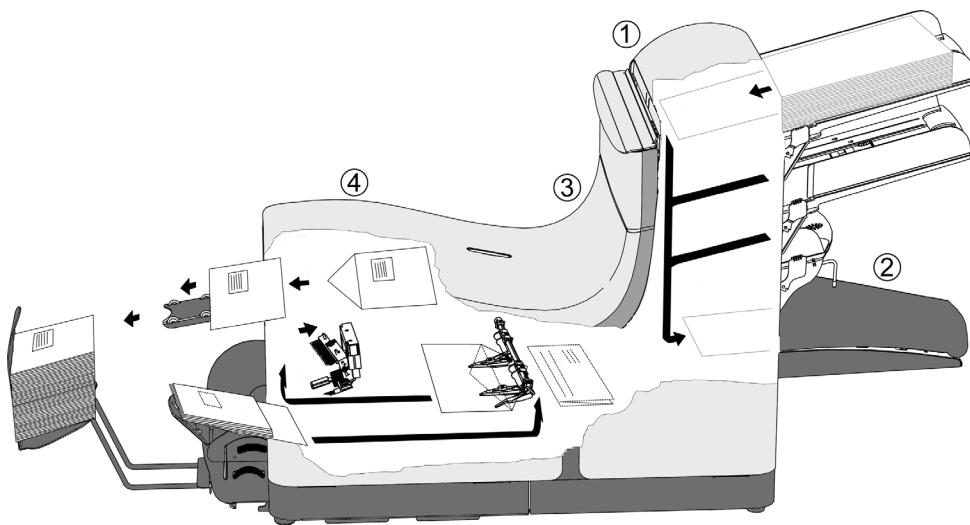



2.2 Operating controls

A : envelope receiving tray

B : envelope slide

C : display

D : upper unit

E : locking hand grip upper unit

F : document feeding tray

G : collator arm

H : collator area

I : power inlet, power switch

J : sensors

K : bellows

L : knobs for clearing stoppages

M : handle for clearing stoppages

N : water tray

O : side cover (opened)

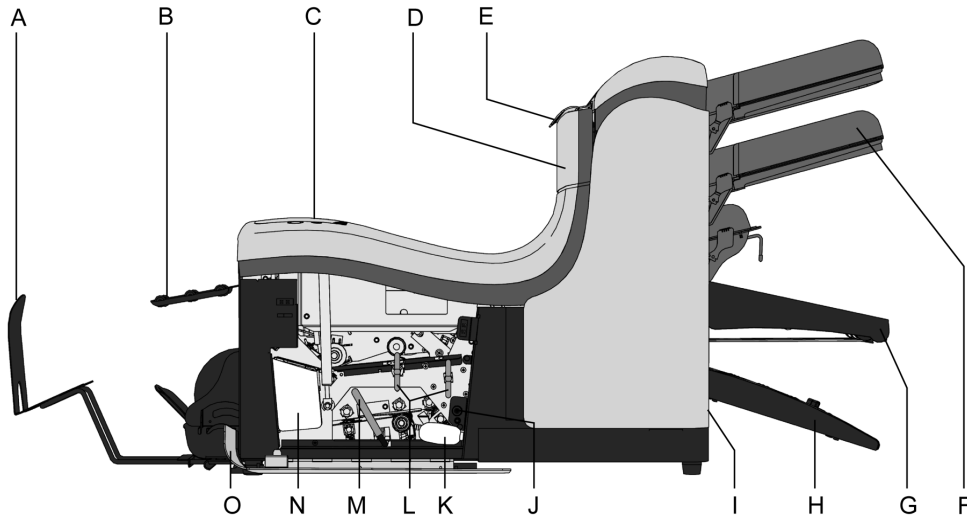

ENGLISH

P : side guides envelope hopper

Q : knob for separation adjustment

R : envelopes support bracket

S : thumbwheel for side guide adjustment

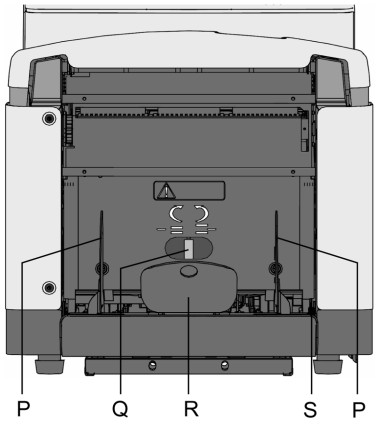

Moistening the brushes

The water tray must always be filled with a special sealing liquid or water and the brushes must be moistened. An extra set of brushes is provided so that one set can be soaked in water. For this a special section is available in the water tray. Refer to chapter "Maintenance".

2.3 Display

The display shows the operating screens and keys for operating the system (see figure below). The keys below are used for the functions: start/stop (combined key) and escape. The four keys on the right of the display are used for the corresponding functions shown in the screens.



Press the start/stop key to start the machine. When the start/stop key is pressed again the machine stops feeding after completing the set. It is possible that there are still documents left in the document feeder (for example a small card). Remove all these documents from the feeder before restarting another job. There can also be envelopes left in the envelope track. These envelopes must be removed when another type of envelopes is required. The escape key can be used to exit a menu without saving any settings.

3. OPERATING THE SYSTEM

3.1 Switching on

The system can be switched on or off with the power switch on the back of the system. Refer to section "Operating controls". After starting up, the display shows "main menu (1)".

3.2 The main menu

The main menu consists of two menus, "main menu (1)" and "main menu (2)". Press key 4 in "main menu (1)", to go to "main menu (2)". Press key 4 again to get back to "main menu (1)".

3.3 Main menu (1)

Main menu (1) shows the following functions (see figure above):

- job info (i),
- other job,
- Fill & Start.

3.4 Job info

When key 1 is pressed in "main menu (1)", the "job info" screen will be displayed (see figure below). Press the escape key to go back to "main menu (1)".

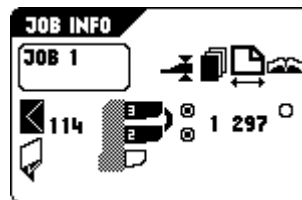

The "job info" screen shows the following job settings:

- envelope (K) or no envelope (X),
- type of document fold (V),
- document double feed detection "on" or "off" (on/off),
- which feeders are selected (black is selected),
- which feeders are linked (feeder swap),
- the number of documents per feeder (114),
- the length of the document in the feeder (1 297),
- daily mail (on/off),
- OMR (Optical Mark Reading) (on/off).



3.5 Other job

Select the desired job in the "Other job" menu. Confirm the job selection with "OK" which will get you back to the "main menu (1)".

3.6 Main menu (2)

Main menu (2) shows the following functions (see figure below):

- reset count,
- insert position,
- job menu.

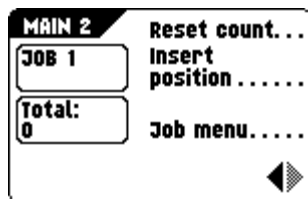

3.7 Reset count menu

After pressing key 1 in "main menu (2)", the counter is set to zero.

3.8 Adjustments for document feeding

Document separation

The document separation for the feeders is set automatically.

Side guides

To adjust the side guides it is best to remove the document feeding tray as follows (see figure below):

- push handle A downwards,

- lift the document feeding tray upwards to unhook it and then pull it out from the feeder,

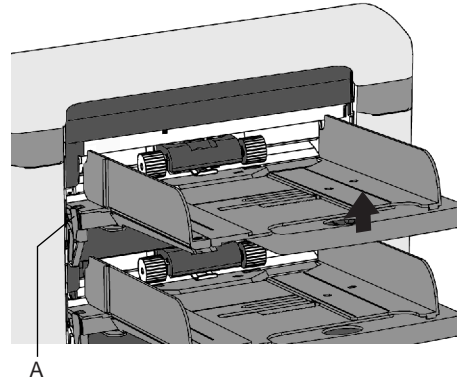

- loosen knob B half a turn (see figure below),
- grab the side guides C in the middle and push them outwards,
- put a small stack of documents between the side guides,
- grab the side guides in the middle and push them towards the documents,
- The space between the side guides and the documents should be such that the documents have just enough play to move freely,
- re-tighten knob B,
- remove the stack of documents.

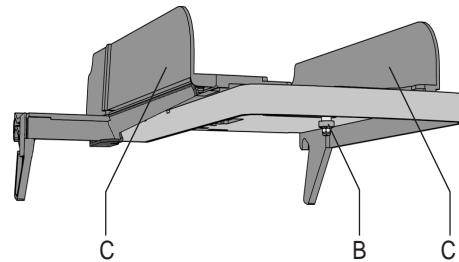

Replace the document feeding tray as follows (see figure below):

- place the document feeding tray under guide A,

ENGLISH





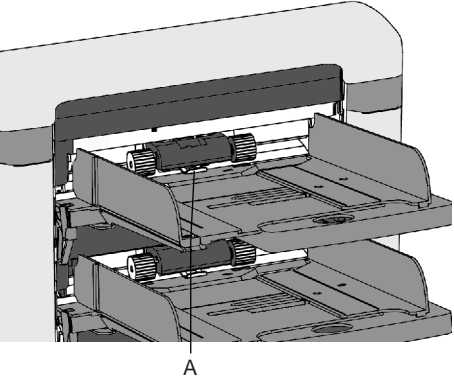











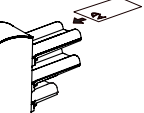
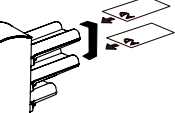
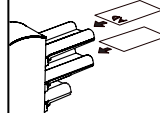
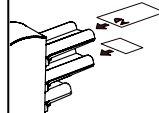

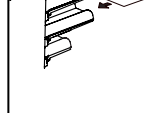

- push the document feeding tray up and then lower it into position.

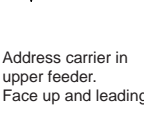
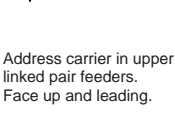
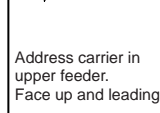
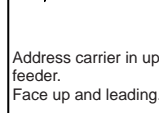

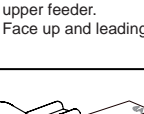
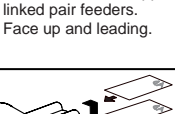
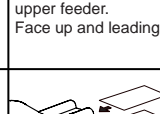
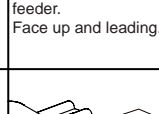

Feeding documents

The feeding of documents is shown in the figure below.

	 one document	 feeder swap	 two documents	 document + enclosure
no fold 				
single fold 				
letter fold 				
double parallel fold 				
zig-zag fold 				
	Address carrier in upper feeder. Face up and leading.	Address carrier in upper linked pair feeders. Face up and leading.	Address carrier in upper feeder. Face up and leading.	Address carrier in upper feeder. Face up and leading.
	Address carrier face down and trailing.	Address carrier in lower linked pair feeders. Face down and trailing.	Address carrier in lower feeder. Face down and trailing.	Address carrier in upper feeder. Face down and trailing.

ENGLISH

Daily mail

The daily mail function can be used for processing documents or sets which can not be processed automatically.

The upper feeder is equipped with a daily mail switch.

Switch to daily mail in the following way:

- select a job where the daily mail function has been set to "on",
- turn the left side guide of the upper feeder downwards,
- the daily mail handle will be visible and can be set. Push the handle towards  to switch to the daily mail function. Push the handle towards **(auto)** to switch back to the automatic function,
- turn the left side guide upwards again.

Filling the document feeder

Open the left side guide by turning it downwards (or the handle for the small feeder). The feed rollers will automatically be lifted. Place a stack of documents between the side guides. Turn the left side guide upwards again (or the handle for the small feeder).

3.9 Adjustments for envelope feeding

Envelope separation

Adjust the envelope separation by turning knob A (see figure below) counter clockwise until two envelopes (flap down and "trailing"), one on top of the other, can be moved backward and forward between the rollers without resistance. Turn knob A clockwise until one envelope will just pass between the rollers.

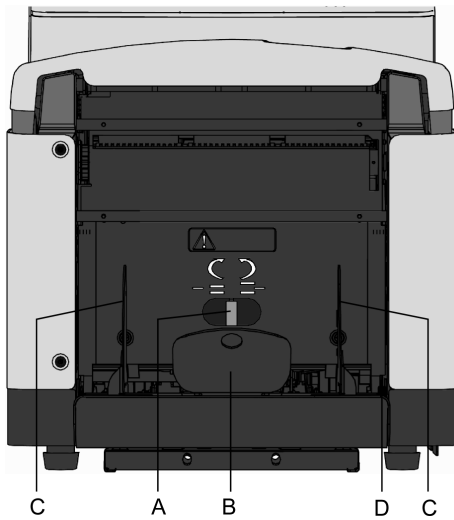

Side guides



The bottom envelope must enter the separator first. Adjust the side guides C (see figure above) by turning the thumbwheel D to provide enough space to move freely. Too much play causes skewing.

Filling the envelope feeder

Fan the stack of envelopes a bit and place the bottom envelope between the separation rollers (flap down and trailing). Sometimes envelopes may skew on the insert table. The envelope support B (see figure above) can be rotated slightly to compensate this. Shift the envelope support B in or out so that the flap side of the envelope is lifted about 20 mm (0.8 inch). Turn the envelope support B so that the weight of the envelopes is distributed evenly on both sides.

Envelope sealing

Envelopes can be sealed or not sealed. To switch sealing "on" or "off", pull the hand grip of the upper cover upward and pull it into the vertical position.

Shift the blue handle towards  to switch sealing off or towards  to switch sealing on.

3.10 Insert position

Press key 2 in the "main menu (2)" to enter the "Insert position" menu (see figure below). Press key 1 in the "Insert position" menu to bring one envelope onto the insert position.

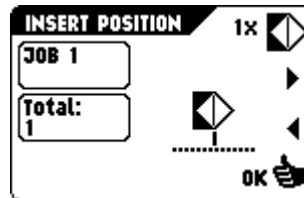

Open the upper cover. The flap folding line must be positioned under the green indicator B (see figure below). If necessary adjust the flap folding line position by pressing key 2 or 3 in the "Insert position" menu.

Each key stroke stops the next envelope 0,5 mm (0.02 inch) to the right (earlier) or to the left (later). Check the settings by pressing key 1 again.

Save the insert position settings with "OK" which will get you back to the "main menu (2)" again.

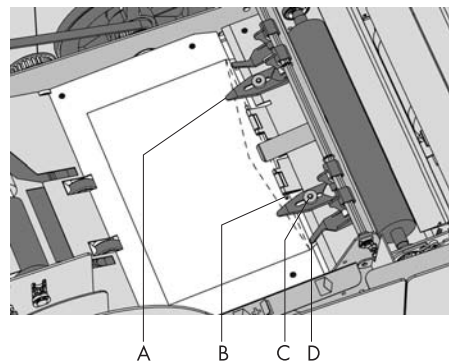



Envelope insert fingers

To adjust the insert fingers A (see figure above) loosen the knurled knob C on top of each finger. Adjust each finger so that the tip enters about 5 mm (0.2 inch) into the envelope. Re-tighten the knurled knob. The fingers can be moved sideways to the desired position. Place the outer fingers D about 5 to 10 mm (0.2 to 0.4 inch) from the edges of the envelope.

Check the position of the insert fingers when changing to a different type of envelope.

3.11 Fill & Start

Before starting the Fill & Start function (see figure below) the adjustment of the side guides and envelope separation must be made manually to obtain correct operation.



The address carrier must be put into the upper feeder.

Only the address position can be adjusted if needed.

Testset

Press key 2 to start a testset in the Fill & Start screen. The settings of the testset will be saved. Only the feeders that feed successfully will be selected.

If needed adjust the address position.

In the Fill & Start job the following options cannot be used:

- feeder swap (the system switches automatically to the upper feeder when the lower feeder is empty and vice versa),
- multifeed (more sheets are fed from the same feeder into the envelope),
- the use of the Fill & Start function is not possible in the "no envelopes" mode.

4. JOB PROGRAMMING

4.1 Job menu

After pressing key 3 in the "main menu (2)", the display shows the "job access" menu and asks for a pin code (2324) to enter (see figure below).



4.2 Job menu (1)

The job menu (1) shows the following functions (see figure below):

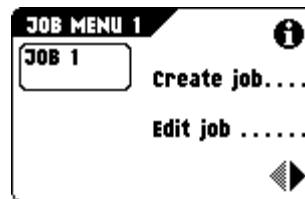

Press and hold key 1 to show the job info.

To go back to the main menu (1) press "esc".

4.3 Create job

Only free jobs will be shown. The "create job" menu shows the following functions.

- job information (i),
- choose a higher job number,
- choose a lower job number,
- select the job to create and confirm with "OK" which will get you to the "job settings" menu (1).

If all jobs are used the display shows "no more free jobs".

To get a free job one has to be deleted.

A new selected job number starts with default settings.

4.4 Edit job

Only programmed jobs will be shown. This menu shows the following functions:

- job information (i),

- choose a higher job number,
- choose a lower job number,
- select the job to edit and confirm with "OK" which will get you to the "job settings" menu (1).

4.5 Job menu (2)

The job menu (2) shows the following functions (see figure below):

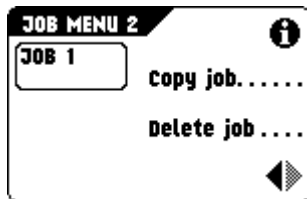

To go back to the main menu (1) press "esc".

4.6 Copy job

The "copy job" menu shows the following functions:

- job information,
- choose a higher job number to copy from,
- choose a higher job number to copy to,
- copy the job with "OK" which will get you to the job menu (2).

In the "copy job" menu it is possible to save a job executed with the Fill & Start function.

4.7 Delete job

This menu shows the following functions:

- job information,
- select a higher job number to delete,
- select a lower job number to delete,
- delete job with "OK" which will get you to the job menu (2).

5. JOB SETTINGS

To program a job use the following order (see figure below):

1. envelope settings menu (✎),
2. document settings menu (📄),
3. fold settings menu (📏),
4. Double Feed Control (DFC) menu (↔),

5. OMR menu (optional) (🗳️),

6. job name menu (name).

Use key 1 or 2 to select a menu and key 3 to edit the selection. Use key 4 to save the job.

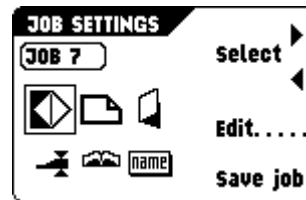

5.1 Envelope settings

When the "envelope settings" menu is selected the following choices are available (see figure below):

1. envelope height (✎). The envelope height can be set between 90 mm (3.5 inch) and 162 mm (6.38 inch).
2. no envelopes (✕). To process without envelopes (fold only).

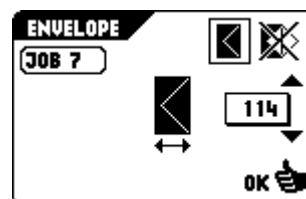

5.2 Document settings

When the "document settings" menu is selected the following choices are available (see figure below):

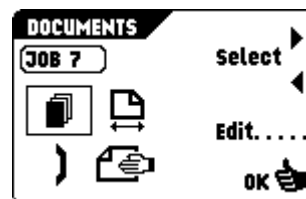



1. set number of documents per feeder (📄). The number of sheets per feeder can be set between 0 and 3. A feeder can be deselected by setting the amount of documents to zero. When a feeder is set to daily mail the amount of documents is always 1.
2. set document size (📏). The document size can be set between 90 mm (3.54 inch) and 356 mm (14 inch) in steps of 1 mm (0.04 inch). For the upper station of a 2,5 station system the minimum height is 115 mm (4.60 inch).
3. set feeder swap (🔄). When feeder swap is selected the following choices are available:
 - select the pair of feeders that need to be linked,
 - select linked or unlinked for a pair of feeders,
 - confirm the settings by pressing “OK” which will get you back to the “job settings” menu. When a pair of feeders is linked, the settings of the lower feeder will be used and shown in the display.
4. set daily mail on or off (📧). When daily mail is selected the following choices are available:
 - set the daily mail function on or off,
 - confirm the settings by pressing “OK” which will get you back to the “job settings” menu.

When there are conflicting job parameters a message will be shown.

5.3 Fold settings

When the “fold settings” menu is selected the following choices are available (see figure below):

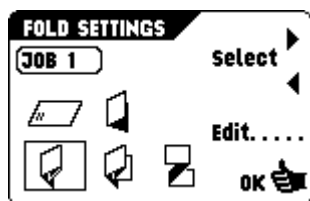

1. no fold (📄). When no fold is selected there are no settings required.

2. single fold (📄). When single fold is selected and edit is pressed, the following choices are available:
 - move the fold position to the right,
 - move the fold position to the left,
 - confirm the settings by pressing “OK” which will get you back to the “job settings” menu. *The fold length can be minimally 75 mm (2.95 inch) and maximally the length of the longest document used minus 25 mm (1.0 inch).*
3. letter fold (📄). When letter fold is selected and edit is pressed, the following choices are available:
 - select fold number,
 - move the position of the fold to the right,
 - move the position of the fold to the left,
 - confirm the settings by pressing “OK” which will get you back to the “job settings” menu. *The fold length of the first fold can be minimally 75 mm (2.95 inch) and maximally the length of the longest document used minus 50 mm (2.0 inch). The fold length of the second fold can be minimally the length of the first fold plus 25 mm (1.0 inch) and maximally the length of the longest document used minus 25 mm (1.0 inch).*
4. double parallel fold (📄). When double parallel fold is selected and edit is pressed, the following choices are available:
 - select fold number,
 - move the position of the fold to the right,
 - move the position of the fold to the left,
 - confirm the settings by pressing “OK” which will get you back to the “job settings” menu. *The fold length of the first fold can be minimally 75 mm (2.95 inch) and maximally the length of the longest document used minus 50 mm (2.0 inch). The fold length of the second fold can be minimally the length of the first fold plus 25 mm (1.0 inch) and maximally the length of the longest document used minus 25 mm (1.0 inch).*
5. zig-zag fold (📄). When zig-zag fold is selected and edit is pressed, the following choices are available:
 - select fold number,
 - move the position of the fold to the right,
 - move the position of the fold to the left,

- confirm the settings by pressing "OK" which will get you back to the "job settings" menu.
*The fold length of the first fold can be minimally 75 mm (2.95 inch) and maximally the length of the longest document used minus 100 mm (4.0 inch).
 The fold length of the second fold can be minimally the length of the first fold plus 25 mm (1.0 inch) and maximally the length of the longest document used minus 75 mm (3.0 inch).*

5.4 Double Feed Control

When the "DFC settings" menu is selected the following functions are available (see figure below):

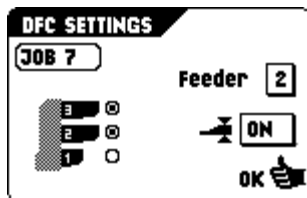

5.5 OMR settings (Optional)

Refer to the chapter "Optical Mark Reading".

5.6 Job name

This menu shows the following functions (see figure below):

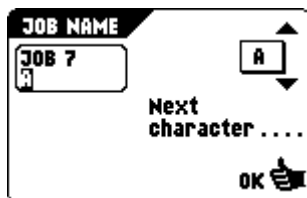

6. OPTICAL MARK READING (OPTIONAL)

The folding and inserting system can be equipped with Optical Mark Reading. With this option the system reads optical marks that have been specially printed on the documents. This code contains information about the processing of the documents. A set can have a varying number of sheets. The document with the printed code is placed in the upper feeder.

6.1 Adjustments

Reading head position

The reading head must be placed according to the (horizontal) position of the printed marks on the documents. To adjust the reading head, proceed as follows:

- take a document with a reading code,
- fold the document on the first mark (see next figure).

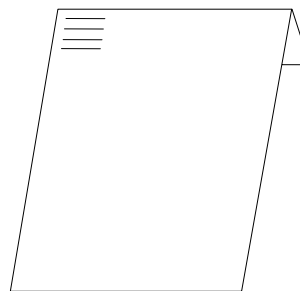

- hold the document onto the ruler (see next figure),
- adjust the reading head A according to the middle of the marks,
- divide the paper guides B along the width of the document.

When the reading head is adjusted it is possible that some paper guides B have to be removed and replaced on the other side of the reading head.

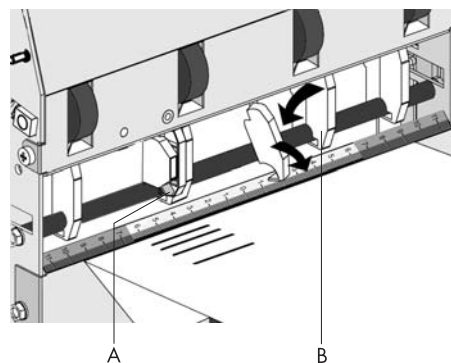

The replacement procedure is the reversal of the removal procedure.



When OMR is selected in a job, the job info screen shows the OMR  symbol.

The OMR settings

Via the job settings the OMR 1 menu can be selected (see figure below). The OMR function can be activated by selecting "Reading on" or "Reading off". The upper feeder is selected automatically for reading. When "OK" is pressed with "Reading off" the "job settings" menu is shown again.

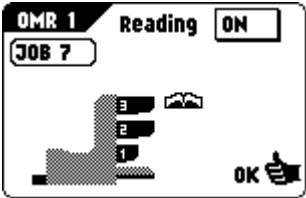

When "OK" is pressed with "Reading on" the OMR 2 menu is shown (see figure below). In the OMR 2 menu the distance from the top of the page to the first mark can be set, and the maximum amount of documents in a set can be chosen. When "OK" is pressed the "job settings" menu is shown again.

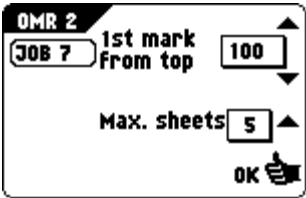







It is not possible to put more than 5 sheets in one set.

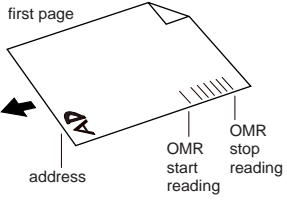
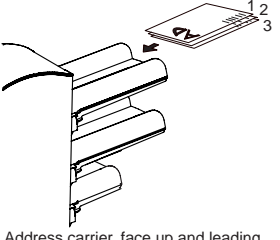

6.2 Feeding documents

The feeding of documents is shown in the figure below.

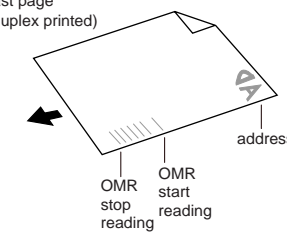
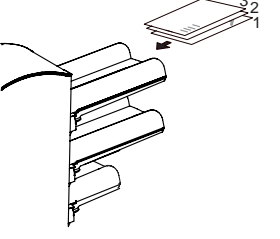
Fold type	Type of documents	Loading positions
no fold  single fold  letter fold  Double parallel fold 	first page 	 Address carrier, face up and leading.
zig-zag fold 	last page (duplex printed) 	 Address carrier, face down and trailing.

6.3 OMR code

Function

In order to handle computer printed documents fully automatically, code marks are printed on each document.

With the first four fold types (refer to section "Feeding documents"), the first sheet of a set always contains the address. In case of a zig-zag fold the address has to be printed on the last page of the set. A full length code is printed on every sheet of a set.

The code on the last sheet of the set contains the insert instruction. The other sheets carry the accumulate instruction. If a parity check is used, this is checked on each sheet. If the set contains only one sheet, it is the "last" sheet. The code must appear in the same location on every page regardless of the actual code length.

Printing quality

Criteria:

- marks should be printed in black,

- marks on the same sheet must have equal intensity,
- for matrix printers near letter quality (NLQ) printed characters are preferred to obtain maximum blackness (double strike),
- be aware of background "noise". This can be color changes on the form, background design, a logo or copy on the opposite side of the sheet that will bleed through and be read by the reading head,
- the ribbon or toner quality must be checked,
- printing must be done on the same position on every sheet.

Minimum code/basic commands

The minimum code is one mark in one line (insert). However for reliability it is advised to use at least 2 marks. The first line is the start mark. A mark printed on the second line means insert, no mark printed means accumulate (this can be reversed on request).



Code position and free area

The code must be printed minimally 15 mm (0.59 inch) away from top and 30 mm (1,18 inch) from the bottom of the sheet. Default the first mark from the top is set to 100 mm (3.9 inch). From the left hand and right hand side 7 mm (0.28 inch) must be kept clear. The code must appear in the same location, and have a consistent number of marks on every page.

Length

Above the first mark and below the last mark a space of 8,5 mm (0.33 inch) must be kept without printing. This means that the minimum code area consists of 6 lines, 2 lines to print the (basic) and 4 lines free space. Line distance may be 2,54 mm (0.1 inch) to 6,35 mm (0.4 inch).

Code width, character space and pitch

The minimum width of the code area is 7 character spaces. From left to right: first 2 characters space unprinted (5 mm; 0.20 inch), then the track mark (3 characters or 6,3 mm; 0.4 inch) and finally 2 character spaces unprinted. Pitch 10 or 12 is accepted. The track mark can be printed by using the "underline" sign (⎓), which must have a thickness of at least 0,2 mm.

Parity mark

By adding a parity mark the reading code can be checked. When the OMR-2 code is used the sum of the marks has to be even.

Safety mark

The safety mark is used as an extra security. With skewed paper the reading head can miss part of the reading code. In these situations the safety mark is not read, and the system will give an error. The safety mark also indicates the end of the reading code. This mark always has to be printed on the document if it has been activated. Criteria:

- the marks chosen are always used in the above sequence,
- if a function is suppressed the following function will move upwards one line,

- the chosen code is used on all material which will be processed by the Optical Mark Reading,
- the length of the code with its mark definition is a service setting.

7. FAULT FINDING

7.1 General

In the system the following error types are possible:

- paperflow errors,
- reading errors (when the system is equipped with Optical Mark Reading),
- technical errors.

If an error occurs the display shows a screen with an error description and a suggested solution.

When a paperflow error occurs the following functions are available:

- show more information,
- reset the error after solving the problem (the error screen will disappear).

The black arrow or a black feeder indicates where the problem occurs.

When a reading or double feed control error occurs, the document stops in the collator area.

The operator must remove the document(s) from the collator area and must complete the set manually!

When there is a technical problem the display shows a message. The error cannot be solved by operating personnel and assistance of the service support is needed.

First write down the error code, then switch the inserter off and on again, to verify system operation. When the error still occurs contact your service organization.



7.2 Clearing stoppages

For clearing stoppages the three sections of the system can be opened (A, B and C).

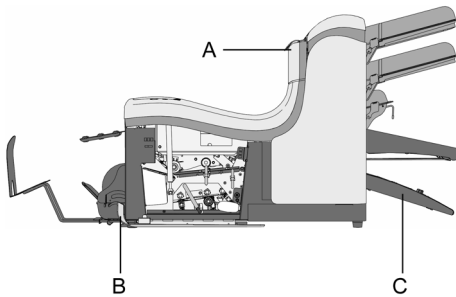

Lower envelope track

Remove the envelopes as follows (see figure below):

- open the side cover A,
- lower and hold the handle B to the left and remove the envelope(s) from the lower envelope track,
- release the handle B,
- close the side cover.

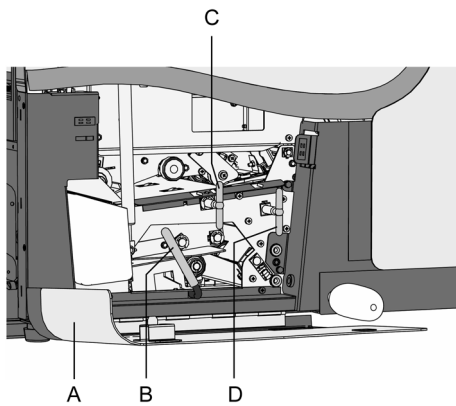

Reset the error after solving the problem with (key 4).

If needed, envelopes and documents can be transported manually by turning knob C clockwise. To transport envelopes manually to the insert table or to the lower envelope track, turn knob D clockwise.

Folder

Remove the documents as follows:

- pull the hand grip up and pull the upper cover into vertical position,
- remove the documents from the folder,
- close the upper cover until it clicks.

Reset the error after solving the problem with key 4.



7.3 Operator troubleshooting

Symptom	Possible cause	Remedy	Section
The machine cannot be started after switching on.	Machine not connected to mains.	Connect the machine to the mains.	-
	Fuse is blown.	Replace fuse below power switch.	-
	A cover is opened.	Close the covers	-
Machine stops with envelope at insert position (flap not open).	Envelopes stacked reversed in the hopper.	Check envelope feed adjustments. Place envelopes correctly in hopper.	Adjustments for envelope feeding.
	Envelope flap sticks.	Store envelopes according to specifications.	Specifications.
	Wrong envelope type used (not according specifications or job settings).	Change envelopes according to specifications.	Specifications.
Envelopes are double fed.	Envelope separation not correctly adjusted.	Check separation settings, adjust if needed.	Adjustments for envelope feeding.
	Envelopes not placed properly in the hopper.	Check and replace if needed.	Adjustments for envelope feeding.
Envelope stop skewed.	Side guides of the envelope hopper are set too wide.	Check side guides and adjust if needed.	Adjustments for envelope feeding.
Envelopes are fed irregularly.	Hopper almost empty.	Refill hopper.	Adjustments for envelope feeding.
	Separation set too narrow.	Check separation settings, adjust if needed.	Adjustments for envelope feeding.
	Side guides set too narrow.	Check side guides and adjust if needed.	Adjustments for envelope feeding.
	Envelope support not positioned correctly.	Reposition the envelope support.	Adjustments for envelope feeding.
Flap is wrinkled and sometimes not opened.	Envelope not within specifications.	Check specifications and change envelopes if needed.	Specifications.



Symptom	Possible cause	Remedy	Section
	Flap sticks.	Store envelopes according to specifications.	Specifications.
	Flap curled.	Envelopes stored or manufactured improperly.	Specifications.
	Separation set too narrow.	Check separation settings, adjust if needed.	Adjustments for envelope feeding.
Fingers are placed on top of the envelope.	Fingers adjusted too deep into the envelope.	Check fingers position, adjust if needed.	Envelope insert fingers.
	Envelope stops too early.	Check envelope stop position, adjust if needed.	Envelope insert fingers.
Machine stops while inserting (stoppage at the inserting point).	Fingers not correctly adjusted.	Check fingers position, adjust if needed.	Envelope insert fingers.
	Inserted document too long for used envelope.	Check fold settings.	Fold settings menu.
	Envelope throat incorrect.	Check envelope specifications.	Specifications.
	Envelope glued inside.	Eliminate faulty envelopes.	Specifications.
	Window not glued properly.	Eliminate faulty envelopes.	-
Flap not sufficiently moistened.	Water level low.	Check water level, refill if needed.	Moistening the brushes.
	Brushes dry.	Check brushes, replace if needed by the extra soaked set.	Moistening the brushes or Maintenance.
	Brushes dirty.	Check brushes, clean if needed.	Maintenance.
	Moistening felt dry.	Check the moistening felt, refill water tray if needed.	Moistening the brushes.
	Moistening felt dirty.	Check the moistening felt, clean if needed.	Maintenance.
	Moistening brushes inactive.	Activate the moistening brushes.	Envelope sealing.





Symptom	Possible cause	Remedy	Section
Envelope not filled properly or envelope flap not closed properly.	Inserted document too big.	Check fold settings, adjust if needed.	Fold settings menu.
	Document not inserted deep enough.	Check adjustment of envelope stop position and fingers.	Envelope insert position.
No document fed.	Feeder empty.	Refill feeder.	Filling the document hopper.
	Separation set too wide.	Adjust the separation.	Document separation.
	Side guides set too narrow.	Adjust the side guides.	Side guides.
Skewed documents fed.	Side guides set too wide.	Adjust side guides.	Side guides.

ENGLISH



7.4 OMR error codes

 error description	 suggested solution	 information	Error code
Reading error.	Remove the documents and adjust the 1st mark from the top position correctly.	Wrong window position.	3 : 112
Reading error.	Remove the current suspected set and check the next set.	Suspected set after error.	3 : 114
Reading error.	Remove the documents and adjust the reading head. Adjust the 1st mark from the top position correctly. When the error still occurs, contact your service organization.	Not enough marks.	3 : 120
Reading error.	Remove the documents and check the used OMR code.	No basic command.	3 : 122
Reading error.	Remove the documents and check the used OMR code. Adjust the reading head.	Wrong parity in code.	3 : 126
Reading error.	Remove the documents and check the used OMR code (flex-dongle).	Undefined mark found	3 : 127
Reading error.	Remove the documents and check the used OMR code's (mark line distance).	Wrong mark distance.	3 : 128
Reading error.	Remove the documents and check the used OMR code (flex-dongle).	Too many marks.	3 : 129
Too many sheets.	Remove the documents. Check the set and complete the set manually.	Set size exceeded.	3 : 134
Incomplete set.	Remove the documents. Check the set and complete the set manually.	Part of previous set.	3 : 135

Service assistance is needed for the error codes with the message "technical failure". First write down the error code, then switch the inserter off and on again, to verify system operation. When the error still occurs contact your service organization.



8. MAINTENANCE

8.1 Servicing



Disconnect the mains supply before performing any maintenance.



The user must not attempt to service the appliance beyond that described in this operator manual. All other servicing must be carried out by qualified service personnel only. Please contact your authorized distributor.

8.2 General cleaning

The system must be kept in proper condition by regularly removing dust, paper remains, etc. Clean the sealing table and rubber rollers when dirty. This can be done by using a slightly wetted cloth soaked in warm water.

Do not clean the display with water or a cleaning liquid.

8.3 Cleaning the brushes

Clean the brushes when dirty or saturated with glue. An extra set of brushes is provided. The best procedure is to always soak one set of brushes and use the other set. In that way there is always a clean set of brushes ready for usage.

The brushes can be removed one by one by pulling them straight off the brush holder. When replacing the brushes, align the studs on each brush with the respective holes in the brush holder.

The brushes should be cleaned once a week.

8.4 Cleaning the moistening felt

Clean the moistening felt and water tray when dirty or saturated with glue.

8.5 Cleaning the sensors

When the display shows a message like "Track sensor dusty", the sensors on the envelope or document path must be cleaned. The screen on the display indicates which sensor(s) must be cleaned.

The sensors can be cleaned by using the bellow located behind the side cover.

For cleaning the envelope track sensor, put the bellow in the hole (refer to the section "Operating controls"). Squeeze a few times firmly to blow away the dust from the sensor. Repeat this procedure for the other hole for cleaning the flap sensor.

9. OPTIONS

Optical Mark Reading

The system can be equipped with optical mark reading. With this reading the system reads optical marks that have been specially printed on the documents. This code contains information about the processing of the documents.

Side exit

At the rear exit a side exit can be fitted by the service organization. The side exit can be fitted instead of the standard envelope receiving tray. The side exit allows a conveyor, conveyor/stacker or a franking machine to be fitted in line with the machine.

When a side exit is ordered, a receiving tray will be delivered with it. The side exit can be mounted for exiting envelopes to the left or to the right.

10. SPECIFICATIONS

This operator manual refers to machines as from machine number 04 DO-5001 or higher.

